

KOMBI MASSE

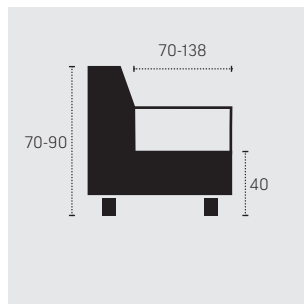

C658562
3-OTM

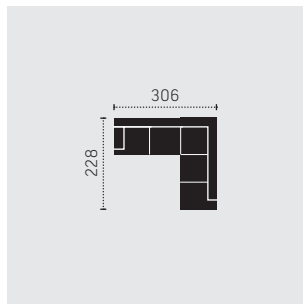

C658563
OTM-3

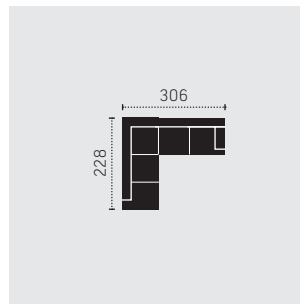

C658690
3-REC BREIT

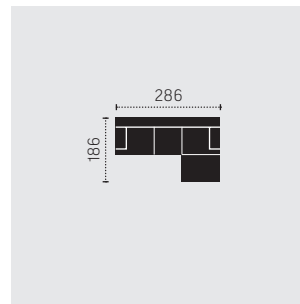

RFE: Relaxfunktion
ST: Sitztiefenverstellung

Masse in Zentimeter

C658691
REC BREIT-3

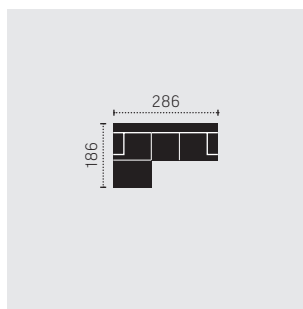

C658695
REC BREIT-3-OTM

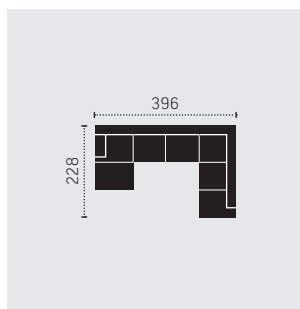

C658696
OTM-3-REC BREIT

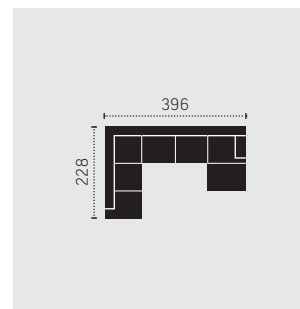

C658740
3RFE-OTM/ST

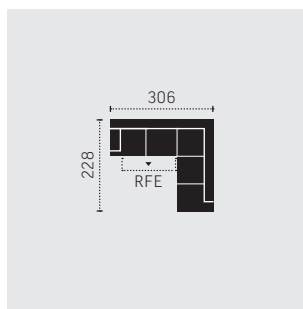

C658741
OTM/ST-3RFE

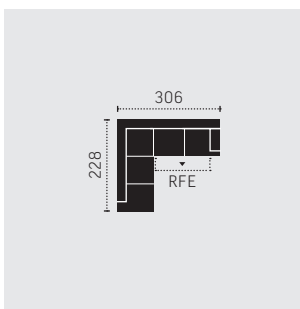

C658760
3RFE-REC-BREIT

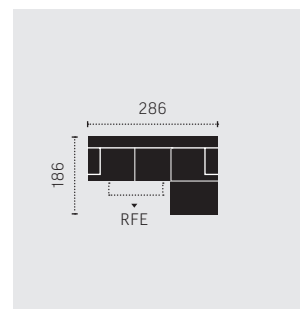

C658761
REC-3RFE-BREIT

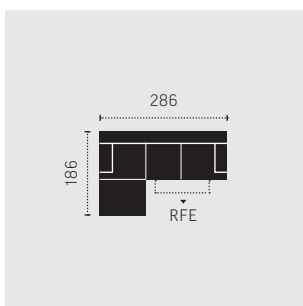

C658782
REC BREIT-3RFE-OTM/ST

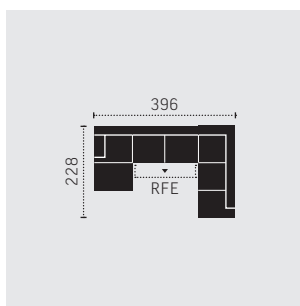

C658783
OTM/ST-3RFE-REC BREIT

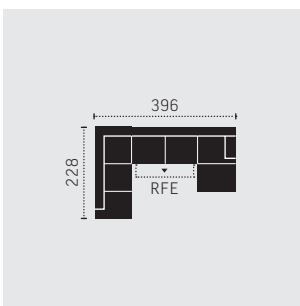

STAND: 10/2025

KOMBI MASSE

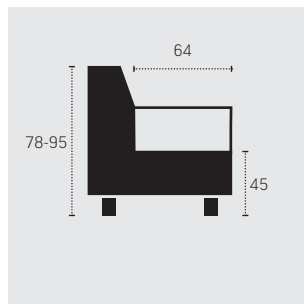

C658805

Hocker

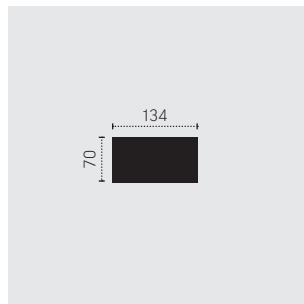

C658970

Nierenkissen 2x74x31/1x85x31

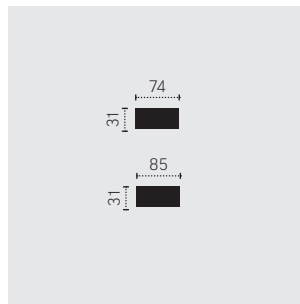

C658975

Nierenkissen 4x74x31/1x80x31

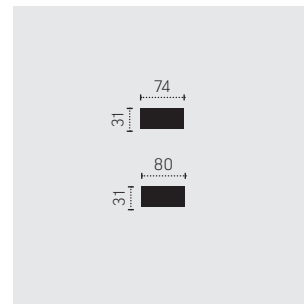

RFE: Relaxfunktion

ST: Sitztiefenverstellung

Masse in Zentimeter

C658980

Nierenkissen 4x74x31/1x80x31/
1x85x31

